

20" Wood Cutting Bandsaw

(Model 28-640, Single Phase Electricals)
(Model 28-641, Three Phase Electricals)

INSTRUCTION MANUAL



DATED 2-6-98

PART NO. 1346911
© Delta International Machinery Corp. 1998

 **DELTA**

TABLE OF CONTENTS

SAFETY RULES	3
UNPACKING	4
CLEANING THE BANDSAW	4
SELECTING FLOOR SPACE	5
ASSEMBLY INSTRUCTIONS	
Assembling Table	5
Assembling Dust Chute	5
Assembling Fence To Table	5
CONNECTING SAW TO POWER SOURCE	
Power Connections	6
Single Phase Installation	6
Three Phase Installation	6
OPERATING CONTROLS AND ADJUSTMENTS	
Start/Stop Switch	7
Blade Brake	7
Adjusting Blade Tension	7
Tracking The Blade	8
Adjusting Upper Blade Guide Assembly	9
Adjusting Upper Blade Guides And Blade Support Bearing	9
Adjusting Lower Blade Guides And Blade Support Bearing	10
Tilting The Table	10
Adjusting Table Positive Stop	11
Fence Adjustments	11
Changing Blades	12
Adjusting Belt Tension	13
Dust Chute	13
Wheel Brush	13
Lubrication	13
PARTS, SERVICE OR WARRANTY ASSISTANCE	14
WARRANTY	16

SAFETY RULES

As with all machinery there are certain hazards involved with operation and use of the machine. Using the machine with respect and caution will considerably lessen the possibility of personal injury. However, if normal safety precautions are overlooked or ignored, personal injury to the operator may result.

This machine was designed for certain wood working applications only. Delta strongly recommends that this machine **NOT** be modified and/or used for any application other than for which it was designed. If you have any questions relative to its application **DO NOT** use the machine until you have written Delta and we have advised you.

DELTA INTERNATIONAL MACHINERY CORP.
MANAGER OF TECHNICAL SERVICES
246 ALPHA DRIVE
PITTSBURGH, PENNSYLVANIA 15238
(IN CANADA: 644 IMPERIAL ROAD, GUELPH, ONTARIO N1H 6M7)

WARNING: FAILURE TO FOLLOW THESE SAFETY RULES MAY RESULT IN SERIOUS PERSONAL INJURY

- 1. FOR YOUR OWN SAFETY, READ INSTRUCTION MANUAL BEFORE OPERATING SAW.** Learn the tool's application and limitations as well as the specific hazards peculiar to it.
- 2. IF YOU ARE NOT** thoroughly familiar with the operation of band saws, obtain advice from your supervisor, instructor or other qualified person.
- 3. MAKE SURE** wiring codes and recommended electrical connections are followed and that machine is properly grounded.
- 4. KEEP GUARDS IN PLACE** and in working order.
- 5. ALWAYS WEAR EYE PROTECTION** (safety glasses or a face shield). Safety glasses must comply with ANSI Z87.1. Everyday eyeglasses only have impact resistant lenses; they are not safety glasses.
- 6. USE** face or dust mask if cutting operation is dusty.
- 7. REMOVE ADJUSTING KEYS AND WRENCHES.** Form habit of checking to see that keys and adjusting wrenches are removed from tool before turning it "ON."
- 8. KEEP WORK AREA CLEAN.** Cluttered areas and benches invite accidents.
- 9. DON'T FORCE TOOL.** It will do the job better and be safer at the rate for which it was designed.
- 10. WEAR PROPER APPAREL.** No loose clothing, gloves, neckties, rings, bracelets, or other jewelry to get caught in moving parts. Roll up sleeves. Non slip footwear is recommended. Wear protective hair covering to contain long hair.
- 11. SECURE WORK.** Use clamps or a vise to hold work when practical.
- 12. DON'T OVERREACH.** Keep proper footing and balance at all times.
- 13. DISCONNECT BANDSAW FROM POWER SOURCE** before servicing and when changing accessories such as blades.
- 14. A COASTING SAW BLADE CAN BE HAZARDOUS.** After completing cut, turn machine off and apply blade brake to stop coasting blade.
- 15. USE RECOMMENDED ACCESSORIES.** The use of improper accessories may cause hazards resulting in product damage or personal injury.
- 16. CHECK FOR DAMAGED PARTS.** Before further use of the tool, a guard or other part that is damaged should be repaired or replaced to ensure that it will operate properly and perform its intended function. Check for alignment of moving parts, binding of moving parts, breakage of parts, mounting, and any other conditions that may affect its operation.
- 17. MAKE SURE** that the saw blade teeth point downward toward the table.
- 18. ADJUST** the upper blade guide about 1/8" above the material being cut.
- 19. MAKE SURE** that blade tension and blade tracking are properly adjusted.
- 20. TURN THE MACHINE OFF,** apply blade brake, and wait for blade to stop before removing scrap pieces from the table.
- 21. ALWAYS** keep hands and fingers away from the blade.
- 22. CHECK** for proper blade size and type.
- 23. DO NOT** attempt to saw stock that does not have a flat surface, unless a suitable support is used.
- 24. HOLD** workpiece firmly against table and feed into blade at a moderate speed.
- 25. NEVER** start the bandsaw with the workpiece contacting the saw blade.
- 26. NEVER** turn the machine "ON" before clearing the table of all objects (tools, scrap pieces, etc.).
- 27. TURN OFF** machine if the material is to be backed out of an uncompleted cut.
- 28. MAKE** "relief" cuts before cutting long curves.
- 29. DO NOT** remove jammed cut-off pieces until blade has come to a complete stop.

SAFETY RULES

(continued)

30. **NEVER** perform layout, assembly, or set-up work on the table while the machine is operating.
31. **AVOID** awkward hand positions where a sudden slip could cause a hand to move into the blade.
32. **DO NOT** cut material that is too small to be safely supported.
33. **ALWAYS** maintain proper adjustment of blade tension, blade guides, and blade support bearings.
34. **NEVER** leave tool running unattended.
35. **SHUT OFF** power, stop blade rotation, and clean the table and work area before leaving the area.
36. **DO NOT** operate machine while under the influence of drugs, alcohol or medication.
37. **WARNING:** The dust generated by certain woods and wood products can be injurious to your health. Always operate machinery in well ventilated areas and provide for proper dust removal. Use wood dust collection systems whenever possible.
38. **SHOULD** any part of your band saw be missing, damaged, or fail in any way, or any electrical component fail to perform properly, shut off switch and disconnect machine from power source. Replace missing, damaged, or failed parts before resuming operation.
39. **ADDITIONAL** information regarding the safe and proper operation of this product is available from the National Safety Council, 1121 Spring Lake Drive, Itasca, IL 60143-3201, in the Accident Prevention Manual for Industrial Operations and also in the Safety Data Sheets provided by the NSC. Please also refer to the American National Standards Institute ANSI 01.1 Safety Requirements for Woodworking Machinery and the U.S. Department of Labor OSHA 1910.213 Regulations. In addition, information regarding general band saw operation is available in the Delta "Getting The Most Out Of Your Band Saw" book. Order by catalog number 11-402.

UNPACKING

1. Your bandsaw is shipped laying on its back in a wooden container. Carefully remove the wooden container, bandsaw table, fence and dust chute which are shipped unassembled.
2. Carefully position the bandsaw in the upright position. **WARNING: THE BANDSAW IS VERY HEAVY AND A MINIMUM OF FOUR PEOPLE WILL BE REQUIRED TO UPRIGHT THE BANDSAW.**

CLEANING THE BANDSAW

The machined and unpainted surfaces have been protected with a coating of rust preventive. This coating should be removed with a soft cloth moistened with kerosene or mineral spirits. **DO NOT USE ACETONE, GASOLINE OR LACQUER THINNER FOR THIS PURPOSE.** After cleaning, cover all unpainted surfaces with a light film of good machine oil.

SELECTING FLOOR SPACE

It is important that the bandsaw be set on a solid, level foundation. If rocking occurs, place metal shims at the corners between the base and the floor. Lag screws or bolts should be used to secure the machine to the floor using the four holes in the base, three of which are shown at (A) Fig. 2.

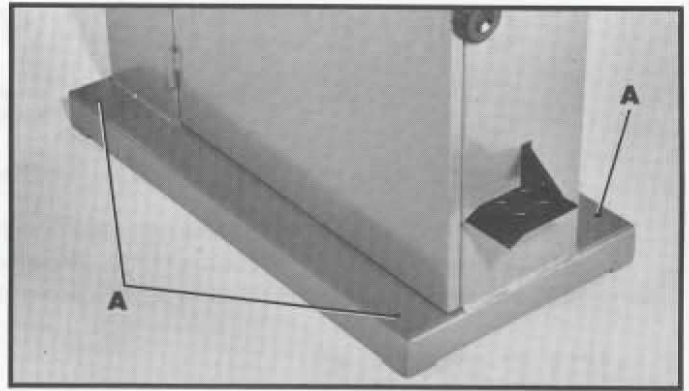

Fig. 2

ASSEMBLY INSTRUCTIONS

ASSEMBLING TABLE

1. Assemble the table assembly (A) to the machine, as shown in Fig. 3, and fasten in place using flat washer (B) and nut (C).

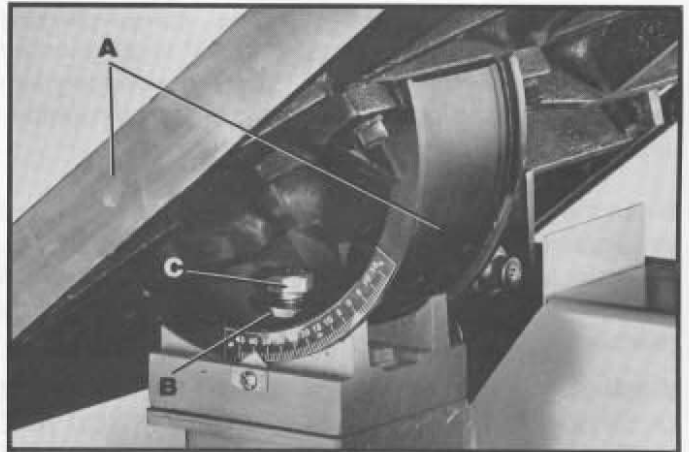

Fig. 3

ASSEMBLING DUST CHUTE

1. Assemble the dust chute (A) Fig. 4, to the machine using the four screws, three of which are shown at (B).

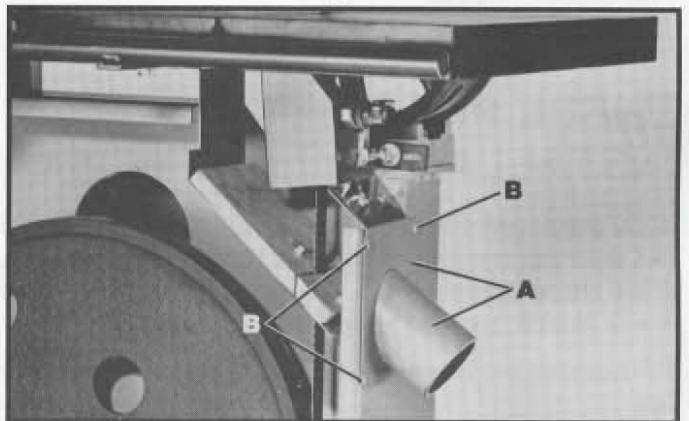

Fig. 4

ASSEMBLING FENCE TO TABLE

The fence (A) Fig. 5, is supplied as standard equipment with your bandsaw and is assembled to the table as follows:

1. Loosen fence locking knob (B) Fig. 5, and position opening (C) of fence bracket over guide rail (D).
2. Tighten fence locking knob (B) Fig. 5, to hold fence in position.

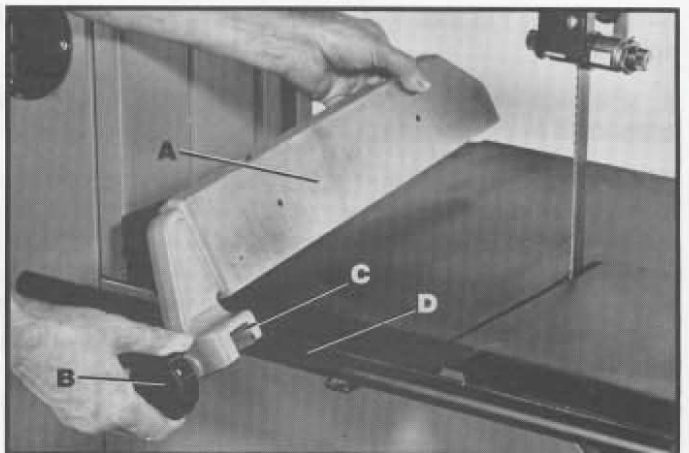

Fig. 5

CONNECTING SAW TO POWER SOURCE

POWER CONNECTIONS

The electrical rating of your 20" Bandsaw is either 230 Volt, Single Phase or 230 Volt, Three Phase.

Before connecting your machine to an electrical power system, be sure the motor rating agrees with the electrical system it is to be connected to. We also recommend that #12 wire, fused with a 20 amp, dual element, time lag fuse, be used to supply power to all machines regardless of their electrical rating.

SINGLE PHASE INSTALLATION

The motor on your machine is wired for 230 Volt, Single Phase operation and the power cord from the starter box is equipped with a plug that has two flat, current-carrying prongs in tandem, and one round or "U" shaped longer ground prong, as shown in Fig. 6. This plug is used only with the proper mating 3-conductor grounding type receptacle, as shown.

When the three prong plug on your machine is plugged into a grounded 3-conductor receptacle, as shown in Fig. 6, the long ground prong on the plug contacts first so that the machine is properly grounded before electricity reaches it.

WARNING: MAKE CERTAIN THE RECEPTACLE IN QUESTION IS PROPERLY GROUNDED. IF YOU ARE NOT SURE, HAVE A CERTIFIED ELECTRICIAN CHECK THE RECEPTACLE.

THREE PHASE INSTALLATION

If you ordered the 230 volt, three phase machine, the motor and electrical components are shipped wired for 230 volt, three phase operation. To connect the machine to the power source, proceed as follows:

1. Remove two hex nuts (A) Fig. 6A, and terminal cover (B).
2. Connect the incoming three phase power lines to terminals (C) Fig. 6B, and green ground wire to ground screw (D).
3. Replace terminal cover (B) Fig. 6A, after machine is connected to the power source.

IMPORTANT: The rotation of the saw blade must be in a clockwise direction when viewed from the front of the machine and the teeth of the blade must be pointed downward toward the table. If the rotation of the blade is incorrect, **DISCONNECT THE MACHINE FROM THE POWER SOURCE** and interchange any two of the three incoming power lines connected to terminal (C) Fig. 6B.

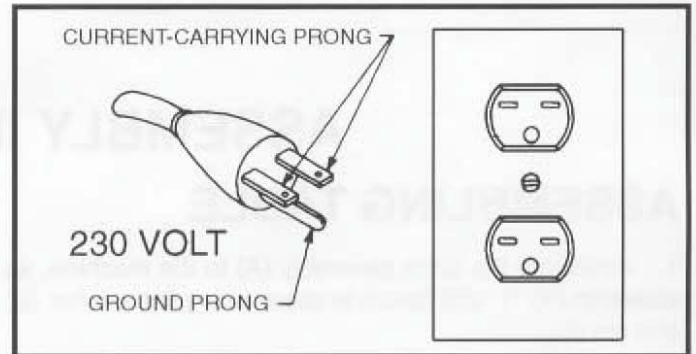

Fig. 6

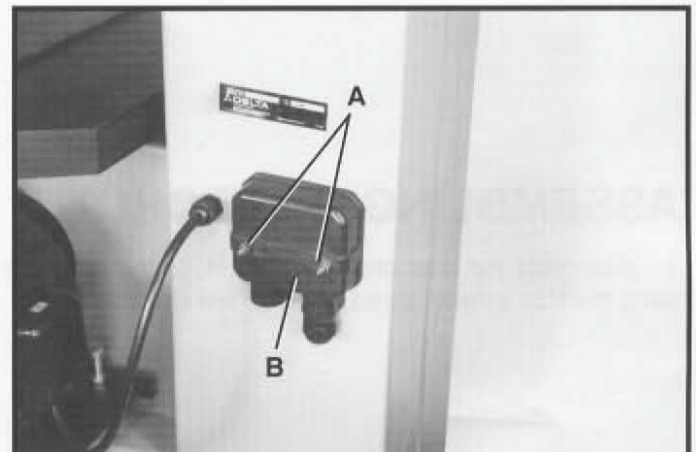

Fig. 6A

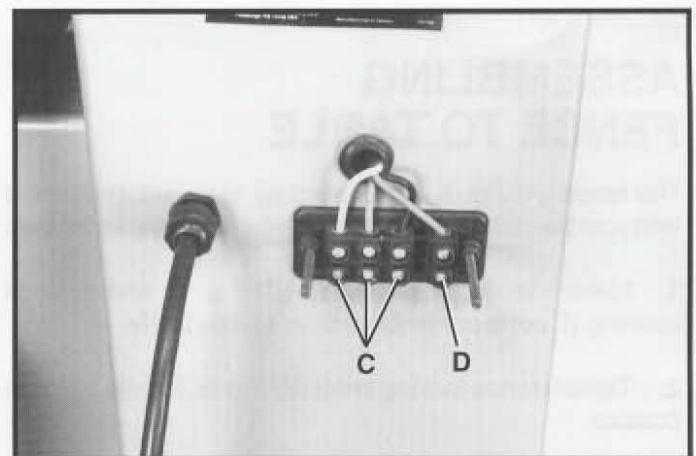

Fig. 6B

OPERATING CONTROLS AND ADJUSTMENTS

START/STOP SWITCH

The start/stop switch is mounted on the bandsaw column for easy accessibility. To start the machine, simply press the start button (A) Fig. 7, and to stop the machine, press the stop button (B).

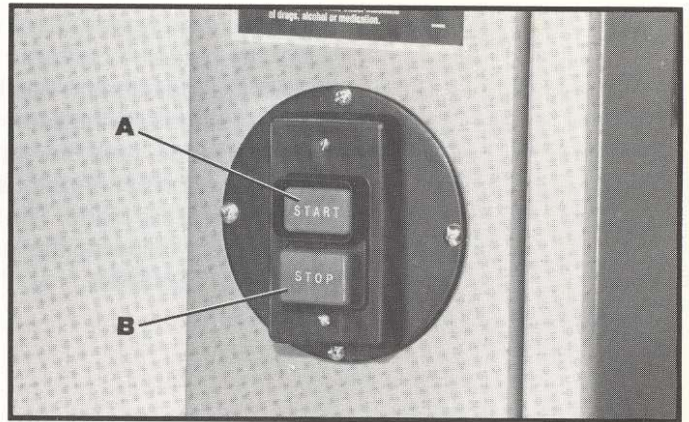

Fig. 7

BLADE BRAKE

After the bandsaw switch is turned off, the brake pedal (A) Fig. 8, should be depressed to stop the blade. When the brake pedal (A) is depressed, the pedal arm (B) activates a brake shoe against the inside rim of the lower wheel (C). The harder the brake pedal (A) is depressed, the faster the blade will stop. **WARNING: A COASTING BLADE CAN BE DANGEROUS. AFTER COMPLETING CUT, TURN MACHINE OFF AND APPLY BLADE BRAKE TO STOP COASTING BLADE.**

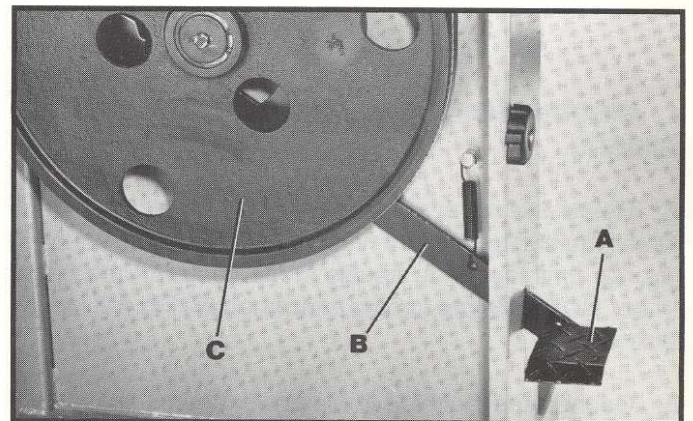

Fig. 8

ADJUSTING BLADE TENSION

The blade is only under slight tension when the bandsaw is shipped from the factory. This is done to prevent weakening of the blade prior to its use. To adjust blade tension, proceed as follows:

1. Turn the blade tension handwheel (A) Fig. 9, clockwise until the pointer (B) Fig. 10, is on the mark on the tension scale (C), which is equal to the blade width.
2. The tension scale (C) Fig. 10, is correct for standard blades used on average work. Experienced operators may rely upon the feel or tone of the blade when adjusting tension. We recommend the use of the tension scale (C) to avoid blade breakage by applying too much or too little tension.
3. When the machine is not in use it is good practice to relax tension on the blade.

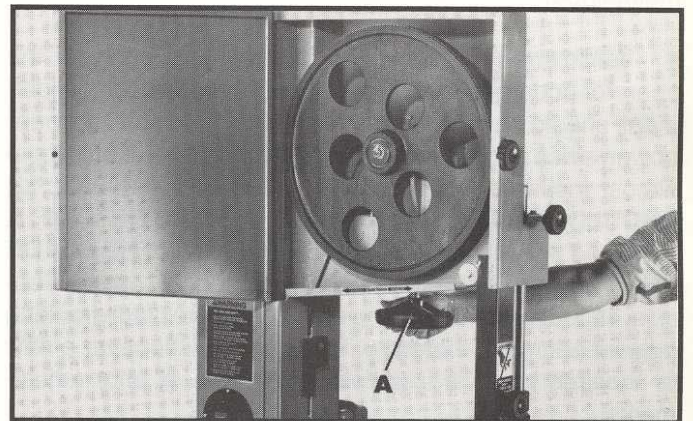

Fig. 9

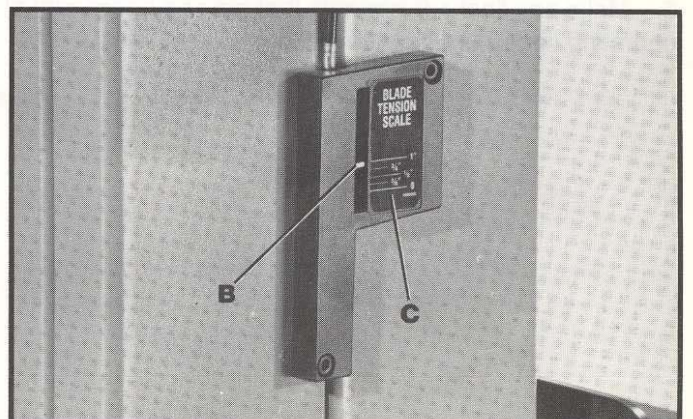

Fig. 10

TRACKING THE BLADE

For accurate work and maximum blade life, it is important that the blade be centered on the upper wheel. When this "tracking" adjustment has been properly made, the blade will run steadily in the same line. Before the tracking adjustment is made, both the upper and lower blade guides and blade support bearings must be moved away from the sides and back of the blade. The blade should also be tensioned properly by following the instructions under "**ADJUSTING BLADE TENSION.**" To "track" the blade, proceed as follows:

1. DISCONNECT THE MACHINE FROM THE POWER SOURCE.

2. Rotate the upper wheel (A) Fig. 11, forward by hand as shown, and turn the tracking adjustment hand knob (B) Fig. 12, until the blade travels in the center of the upper wheel. **NOTE:** Before turning hand knob (B) Fig. 12, loosen locknut (C).

3. Connect the machine to the power source and jog the switch on and off to be certain that proper tracking is being maintained.

4. **WARNING:** To avoid the possibility of injury to the operator or damage to the blade, the initial tracking adjustment should not be made while the machine is under power, since at high speed the blade may run off the wheel almost instantly. **THE TRACKING KNOB (B) FIG. 12, SHOULD BE ADJUSTED ONLY A FRACTION OF A TURN AT A TIME AS REQUIRED TO DRAW THE BLADE ACROSS THE WHEEL.** Each blade has its own tendencies, especially after welding or brazing. The blade tracking adjustment must, therefore, be repeated whenever a new or repaired blade is installed, regardless of prior adjustments.

5. Make any final adjustments that may be necessary at operating speed and tighten locknut (C) Fig. 12.

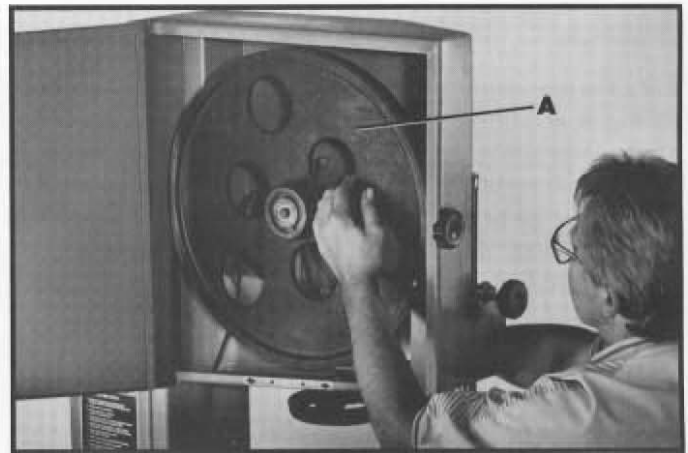

Fig. 11

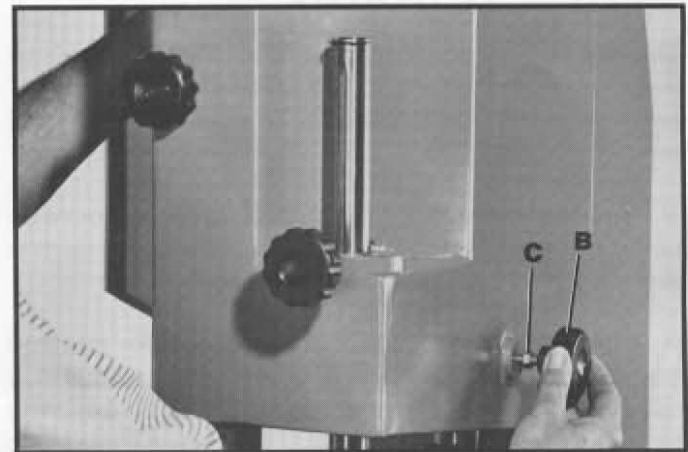

Fig. 12

ADJUSTING UPPER BLADE GUIDE ASSEMBLY

The upper blade guide assembly (A) Fig. 13, should always be set as close as possible to the top surface of the material being cut by loosening lock knob (B) and moving the guide assembly (A) to the desired position. Then tighten lock knob (B). **NOTE:** A knob (C) is provided to assist in raising or lowering the guide assembly and a spring (D) Fig. 14, is provided to prevent the upper guide assembly (A) from falling when the lock knob (B) Fig. 13, is loosened.

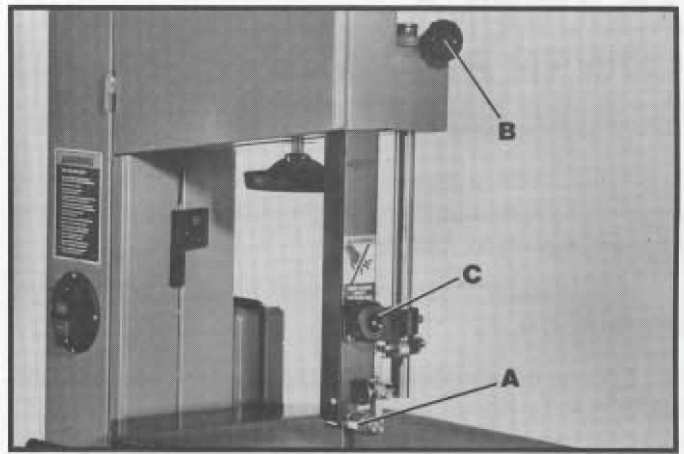

Fig. 13

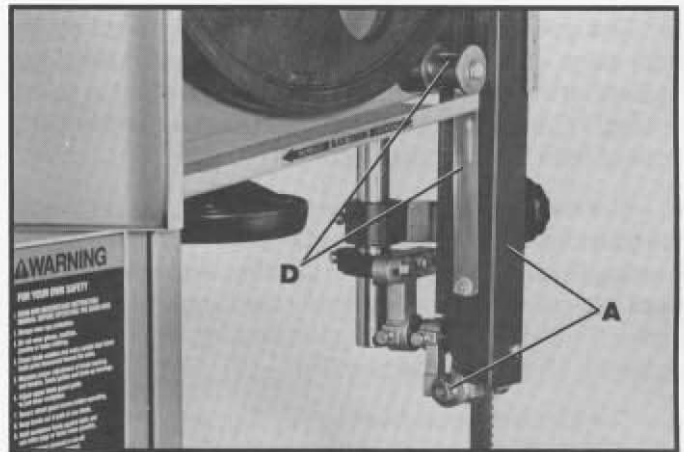

Fig. 14

ADJUSTING UPPER BLADE GUIDES AND BLADE SUPPORT BEARING

The upper blade guides and blade support bearing should be adjusted only after the blade is tensioned and tracking properly. To adjust, proceed as follows:

1. **DISCONNECT MACHINE FROM THE POWER SOURCE.**

2. The upper blade guides (A) Fig. 15, should be adjusted as close as possible (without actually touching) to the sides of the blade by loosening lock knobs (B) and turning adjusting knobs (C). After adjustment is complete, tighten lock knobs (B).

3. The blade guides (A) Fig. 15, should then be adjusted so the front edge of the guides (A) are positioned just behind the "gullets" of the saw teeth. This is done by loosening lock screw (D) and moving the complete guide assembly to the front or back. Then tighten lock screw (D).

4. The upper blade support bearing (E) Fig. 15, prevents the blade from being pushed too far to the rear, which could damage the set in the saw teeth. The support bearing (E) should be adjusted as close as possible to the back of the blade (without actually touching), by loosening screw (F) and moving the support bearing (E) in or out as required. Then tighten screw (F).

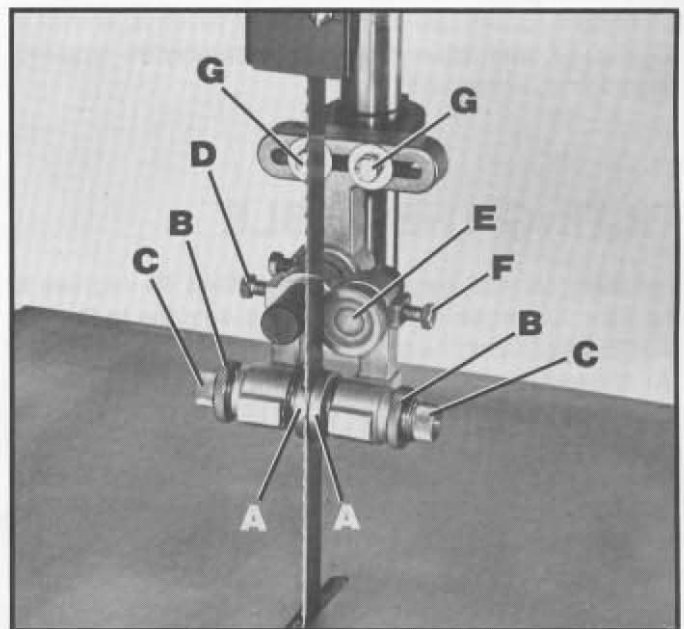

Fig. 15

5. The upper blade support bearing (E) Fig. 15, must also be adjusted so the back of the saw blade will contact the bearing (E) only during the cutting operation. If the complete upper blade guide and support bearing must be moved left or right, loosen two screws (G), adjust as required and tighten two screws (G).

ADJUSTING LOWER BLADE GUIDES AND BLADE SUPPORT BEARING

The lower blade guides and blade support bearing should be adjusted at the same time as the upper blade guides and support bearing as follows:

1. DISCONNECT THE MACHINE FROM THE POWER SOURCE.

2. Loosen the two lock knobs (A) Fig. 16, and adjust the blade guides (B) as close as possible (without actually touching) to the sides of the blade by turning adjusting knobs (C). After adjustment is complete tighten lock knobs (A).

3. The guides (B) Fig. 16, must also be adjusted so the front edge of the guides are positioned just behind the "gullets" of the saw teeth. This is done by loosening screw (D) Fig. 17, and moving the complete guide assembly to the front or back. Then tighten screw (D) Fig. 17.

4. The lower blade support bearing (E) Fig. 16, prevents the blade from being pushed too far to the rear. The support bearing (E) should be adjusted as close as possible to the back of the blade (without actually touching), by loosening screw (F) and moving the support bearing (E) in or out as required. Then tighten screw (F).

5. The blade support bearing (E) Fig. 16, must also be adjusted so that the back of the saw blade will contact the bearing only during the cutting operation. If the complete lower blade guide and support bearing needs to be moved left or right, loosen two screws, one of which is shown at (G) Fig. 17, and adjust the guide assembly as required. Then tighten screws (G).

TILTING THE TABLE

The table on your bandsaw can be tilted 45 degrees to the right, as shown in Fig. 18, and 4 degrees to the left. **NOTE:** When tilting the table to the left, the table stop screw (A) and locknut (B) Fig. 18, must be removed. To tilt the table, proceed as follows:

1. Loosen nut (C) Fig. 19, and tilt table (D) to the desired angle and tighten nut (C). A scale (E) and pointer (F) are provided to indicate the degree of table tilt.

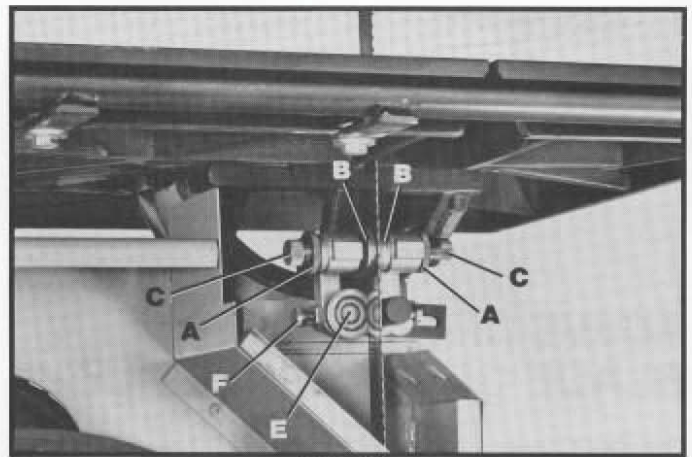

Fig. 16



Fig. 17

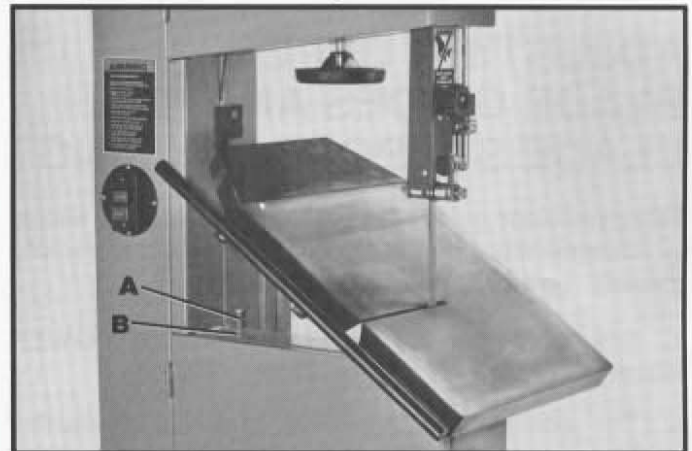

Fig. 18

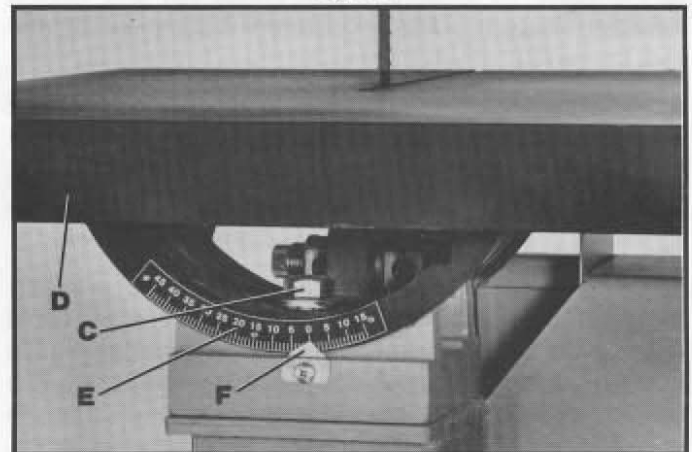

Fig. 19

ADJUSTING TABLE POSITIVE STOP

Your machine is equipped with a positive stop that allows the table to be rapidly repositioned at 90 degrees to the blade after the table has been tilted. To check and adjust, proceed as follows:

1. Tilt the table to the left as far as possible and lock in place.
2. Place a square (A) Fig. 20, on the table with one end of the square against the blade as shown, and check to see if the table is 90 degrees to the blade.
3. If an adjustment is necessary, loosen locknut (B) Fig. 21, and tighten or loosen adjusting screw (C) until head of screw (C) contacts bottom (D) of table when the table is at 90 degrees to the blade. Then tighten locknut (B).

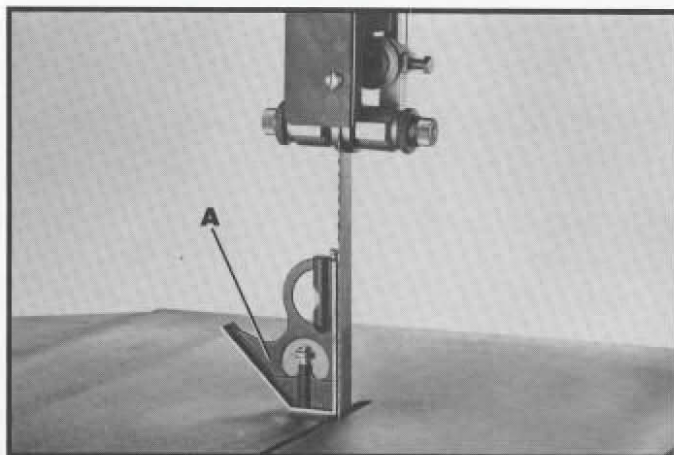

Fig. 20

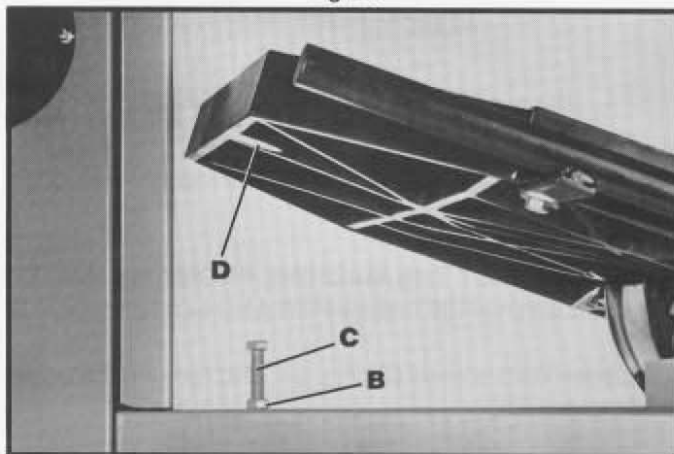

Fig. 21

FENCE ADJUSTMENTS

The fence (A) Fig. 22, can be moved along the guide rail (B) by loosening fence locking knob (C), sliding the fence to the desired position and tightening lock knob (C). To adjust the fence for straight parallel cuts, proceed as follows:

1. Lock the fence (A) in position on the guide rail (B), as shown in Fig. 22, and measure the distance from the blade to the fence.
2. Make a rip cut on a piece of stock which is approximately 24 inches long and check to see if the cut piece is parallel and not cut at a taper.
3. If an adjustment is required, loosen the two screws (D) Fig. 23, and move one end of the guide rail (B) in or out until the fence cuts parallel. Then tighten screws (D).

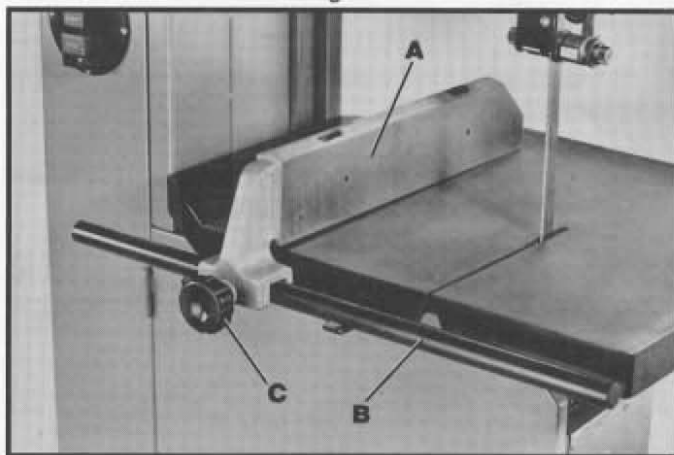

Fig. 22

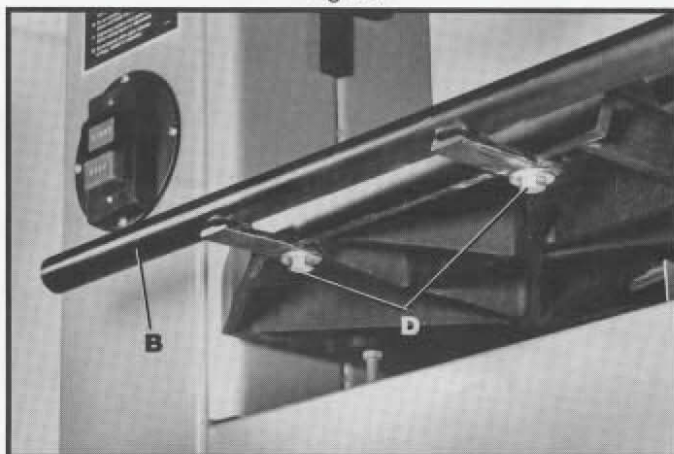

Fig. 23

CHANGING BLADES

Blade length of your band saw is 156-1/2 inches. To change blades, proceed as follows:

1. **DISCONNECT THE MACHINE FROM THE POWER SOURCE AND OPEN THE UPPER AND LOWER DOORS.**
2. Loosen two screws (A) Fig. 24, and remove the upper blade guard (B).
3. Remove two screws (C) Fig. 25, and remove the lower blade guard (D).
4. Release tension on the blade by turning blade tensioning handwheel (E) Fig. 26.
5. Remove the blade from both wheels (F) Fig. 26, and guide it out through the slot in the table.
6. To install a new blade, reverse the above procedure, adjust blade tension, track the blade and adjust both upper and lower blade guides and blade support bearings.

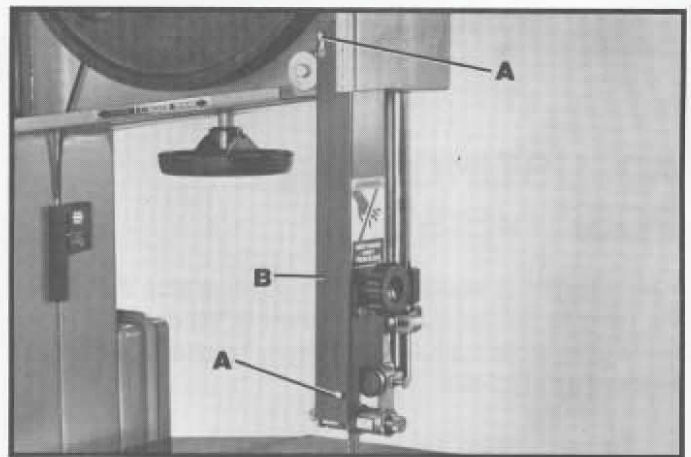

Fig. 24

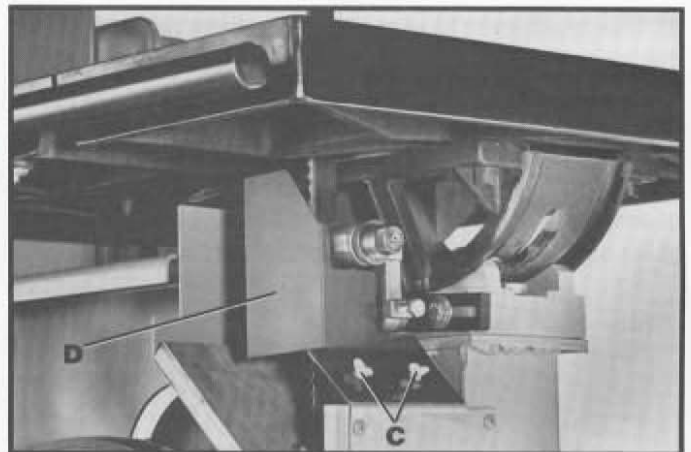

Fig. 25

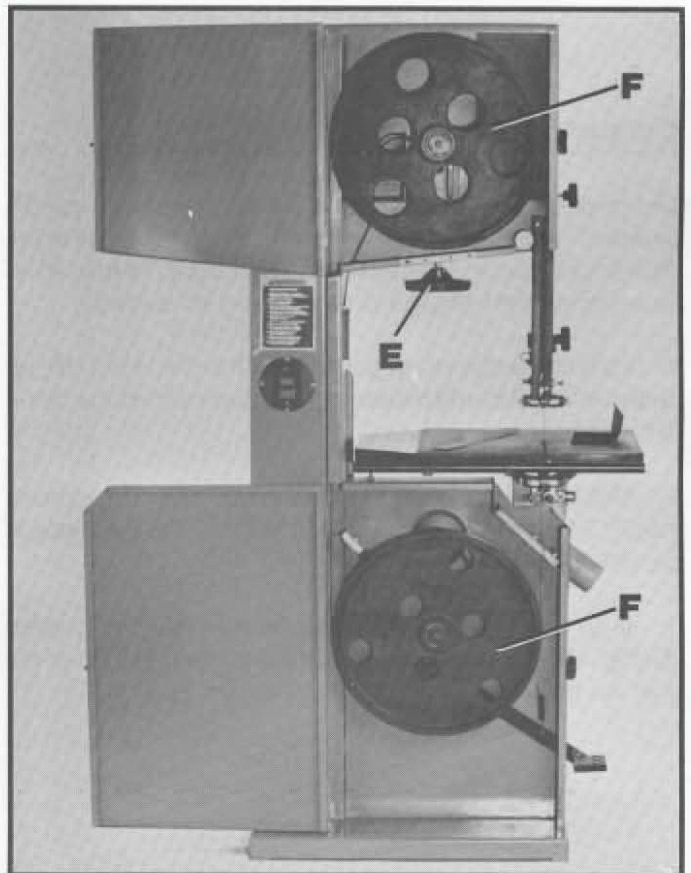

Fig. 26

ADJUSTING BELT TENSION

If it ever becomes necessary to adjust the belt tension on your machine, loosen lock nut (A) Fig. 27, and turn adjusting screw (B) in or out. Turning screw (B) clockwise increases tension and turning screw (B) counterclockwise decreases tension. Tighten locknut (A) after tension has been adjusted.

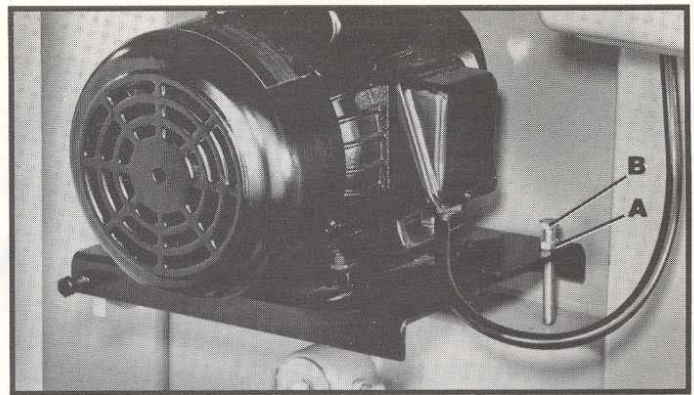

Fig. 27

DUST CHUTE

A dust chute (A) Fig. 28, is supplied with your machine and can easily be connected to a dust collection system. The opening of the dust chute is 3" in diameter.

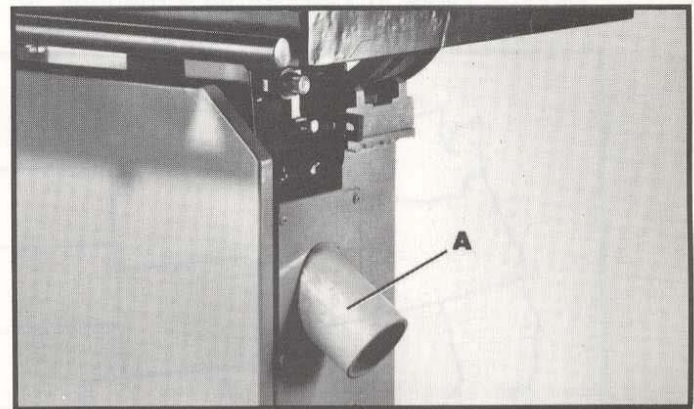

Fig. 28

WHEEL BRUSH

A wheel brush (A) Fig. 29, is provided to keep the blade and tires clean and free of any build-up of chips. Adjustment to the brush (A) can be made by loosening screw (B) and adjusting the brush accordingly.

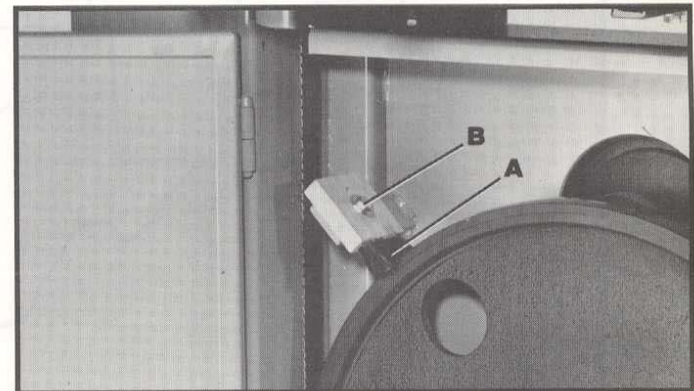

Fig. 29

LUBRICATION

Periodically, the upper blade guides and blade support bearing should be lubricated using #10 weight oil through the oil detents (A) Figs. 30 and 31, using a pressurized oil gun. The lower blade guides and blade support bearing should be lubricated in the same manner.

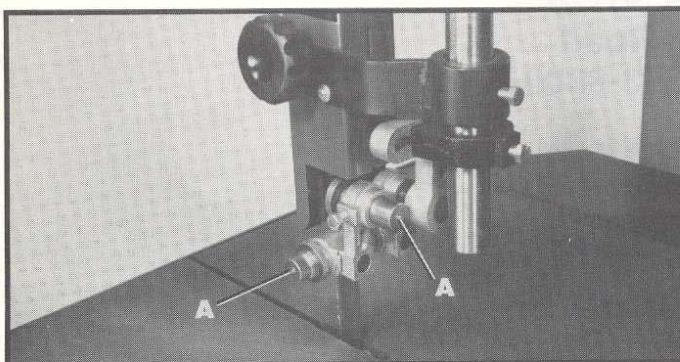

Fig. 30

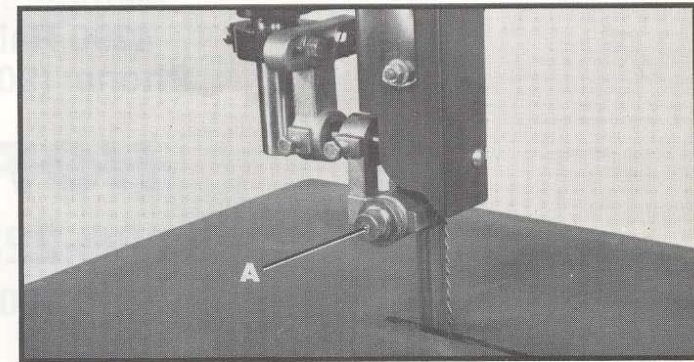

Fig. 31



PARTS, SERVICE OR WARRANTY ASSISTANCE

All Delta Machines and accessories are manufactured to high quality standards and are serviced by a network of factory service centers and authorized service stations listed in your owner's manual. To

obtain additional information regarding your Delta quality product or to obtain parts, service or warranty assistance, please call or fax Delta's toll-free 'hotline' number.



Delta maintains a modern, efficient Parts Distribution Center, maintaining an inventory of over 15,000 parts located in Memphis, Tennessee.

Highly qualified and experienced Customer Service Representatives are standing by to assist you on weekdays from 7:00 A.M. to 6:00 P.M. Memphis time.

HOTLINE
800-223-PART



Two Year Limited Warranty Delta Machinery

Delta will repair or replace, at its expense and at its option, any Delta machine, machine part, or machine accessory which in normal use has proven to be defective in workmanship or material, provided that the customer notifies his supplying distributor of the alleged defect within two years from the date of delivery to him, of the product and provides Delta Machinery with reasonable opportunity to verify the defect by inspection. Delta Machinery may require that electric motors be returned prepaid to the supplying distributor or authorized service center for inspection and repair or replacement. Delta Machinery will not be responsible for any asserted defect which has resulted from misuse, abuse or repair or alteration made or specifically authorized by anyone other than an authorized Delta service facility or representative. Under no circumstances will Delta Machinery be liable for incidental or consequential damages resulting from defective products. This warranty is Delta Machinery's sole warranty and sets forth the customer's exclusive remedy, with respect to defective products; all other warranties, express or implied, whether of merchantability, fitness for purpose, or otherwise, are expressly disclaimed by Delta.